

**RVS1**

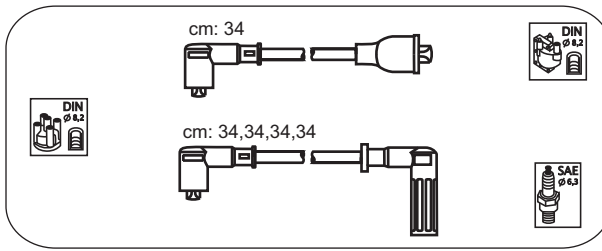

**Rover**  
Montego  
Montego LS

1.3  
1.3

01.86 →  
01.85-12.86

**RVS2**

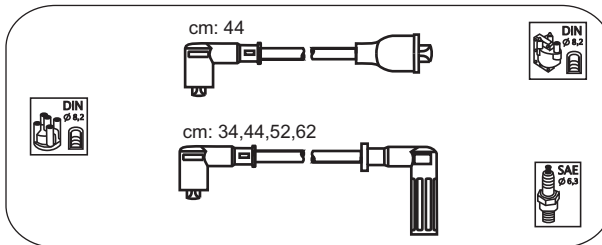

**Rover**  
216

1.6

01.86-09.89

**RVS3**

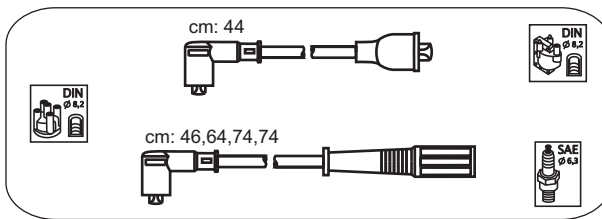

**Rover**  
213

1.3

01.86-09.89

**RVS4**

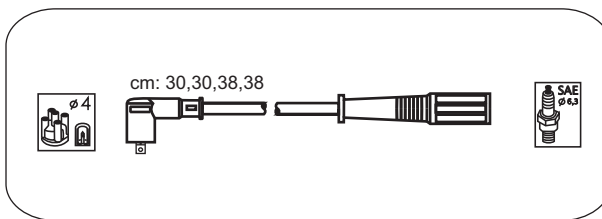

**Rover**  
Mini

1.3

07.96 →

**RVS5**

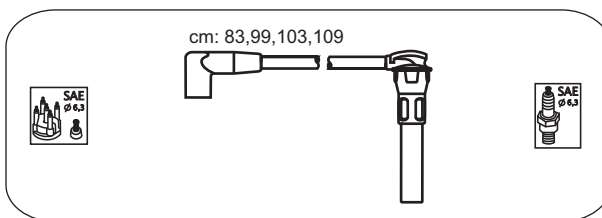

**Rover**  
200 KVi  
MGV VVC  
Tourer

1.8  
1.8i  
1.8i

02.96 →  
12.95 →  
06.96 →

**RVS6**

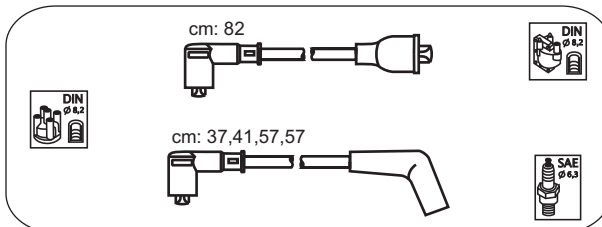

**Rover**  
214  
214 Cabrio  
414 GSi, Si

1.4  
1.4i  
1.4

09.93 →  
01.93 →  
01.93 →

**RVS7**

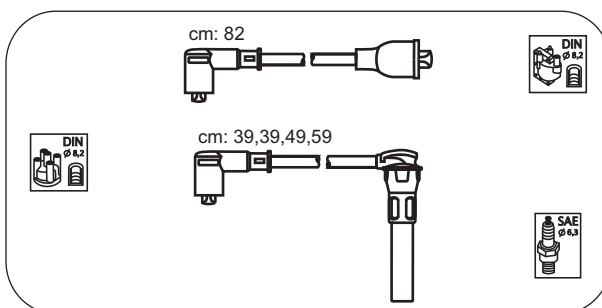

**Rover**  
214 GSi, Si Mot.nr->656311  
214 GSi, Si (XW)  
214 Cabrio  
414 (XW)  
414 GSi, Si

1.4  
1.4  
1.4i  
1.4  
1.4

12.92 →  
01.90-10.95  
01.92 →  
01.93-04.95  
04.90 →

**Rover**

111 Cabrio  
114 S,L,GTA  
211 (RF)  
214

1.1; 1.4  
1.4  
1.2  
1.4i

04.94 →  
09.90 →  
01.98 →  
02.96 →

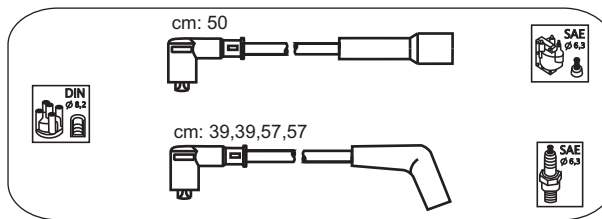

**RVS8**

**Rover**

214 Si  
214 Si, GSi  
216 Si Coupe, Cabrio  
414 Si FLH  
416 Si FLH  
MGF

1.4  
1.4  
1.6i  
1.4  
1.6  
1.8i

02.96 →  
10.89 →  
02.96 →  
06.95 →  
06.95 →  
10.95 →

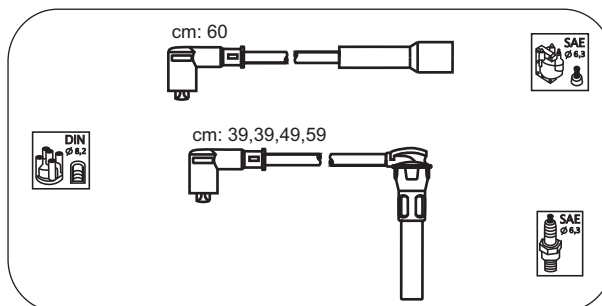

**RVS9**

**Rover**

420 Si, Lux FLH

2.0

04.96 →

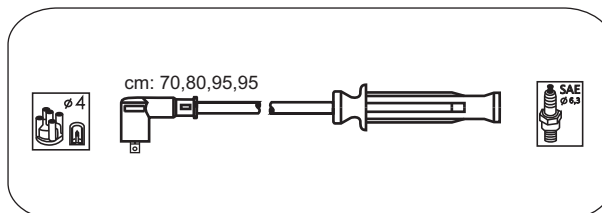

**RVS10**

**Rover**

220 GSi Coupe  
420 GSi, GTi, Si,Turbo  
420 GTi, GSi  
Tourer

2.0  
2.0  
2.0  
2.0i

05.94 →  
01.93 →  
02.92 →  
05.94 →

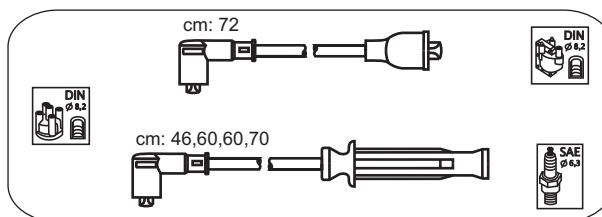

**RVS11**

**Rover**

111 C,L,S Kat.

1.1

09.90 →

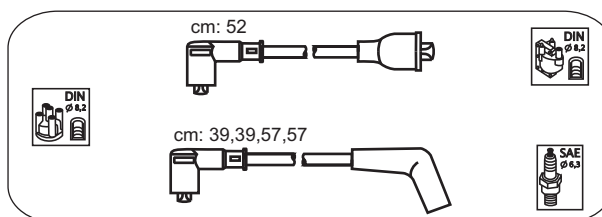

**RVS12**

**Rover**

825 Si Lux, Coupe

2.5

04.96 →

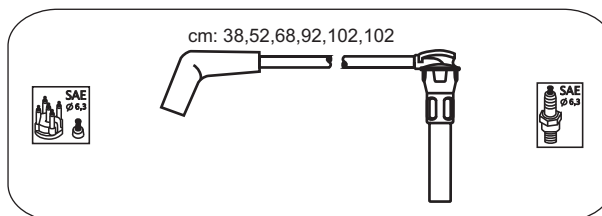

**RVS13**

**Rover**

114 Cabrio (XP)  
114 GTi 16V (XP)  
114 GTi, GSi 16V  
114 GTi, GT 16V Kat.

1.4  
1.4  
1.4  
1.4

03.97-10.98  
03.90-08.91  
08.91-10.95  
05.90 →

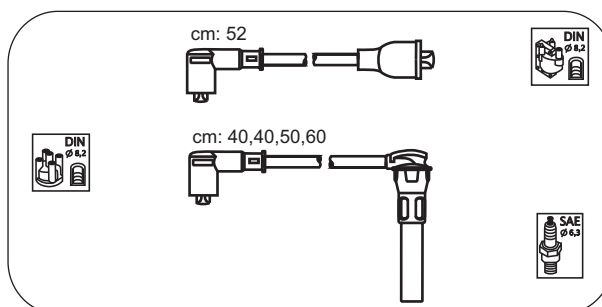

**RVS14**

**RVS15**

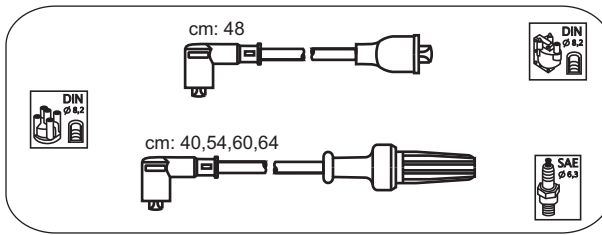

**Rover**

820 Si Kat.  
820 16V Si

2.0  
2.0i

10.88-12.91  
10.88-12.91

**RVS16**

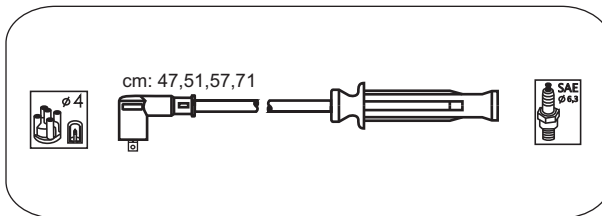

**Rover**

820 Si Kat.

2.0i

01.93 →

**RVS17**

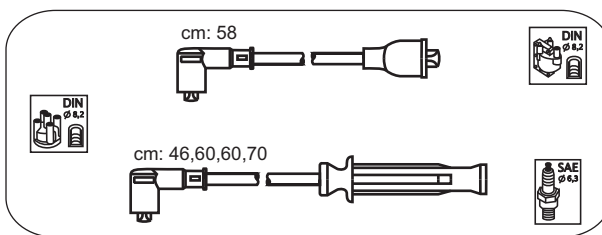

**Rover**

820 SE, SI Hatchback  
820 16V Turbo

2.0  
2.0i

10.86-12.91  
01.88 →

**RVS18**

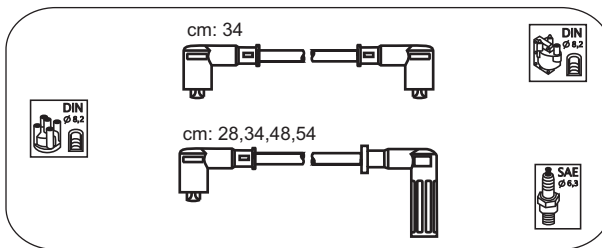

**Rover**

Montego Estate GTI, LXI

2.0

12.90-10.94

**RVS19**

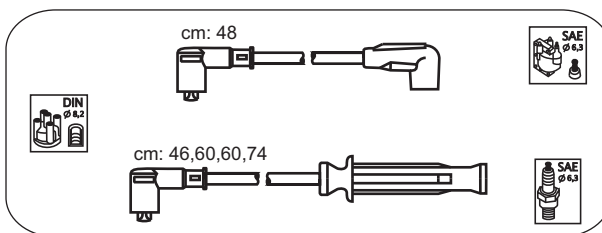

**Rover**

620 Ti

2.0

07.94 →

**RVS20**

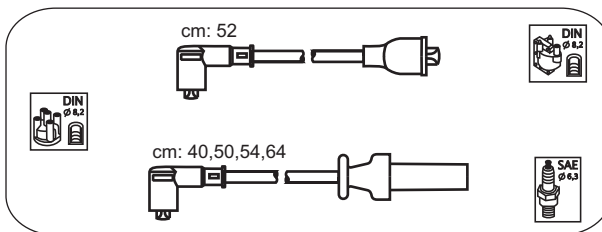

**Rover**

820 16V I, SI (XS)

2.0

10.86-10.88

**RVS21**

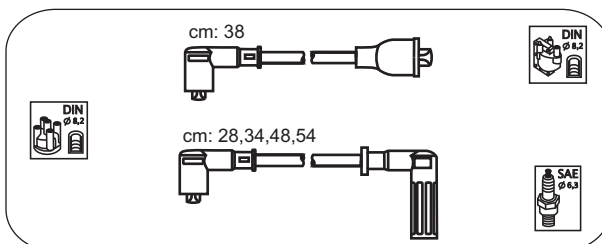

**Rover**

Montego Estate (XE)

2.0

10.88-10.91

**Rover**  
Maestro

1.6 09.90-01.95

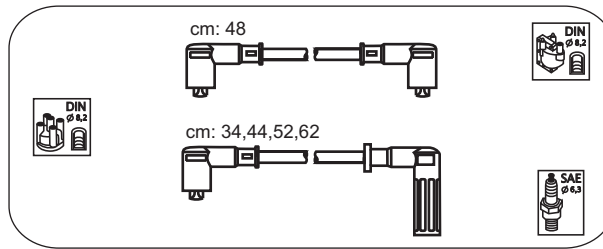

**RVS22**

**Rover**

220 GTi  
820 Sport, Hatchback

2.0 01.91 →  
2.0 05.94-03.96

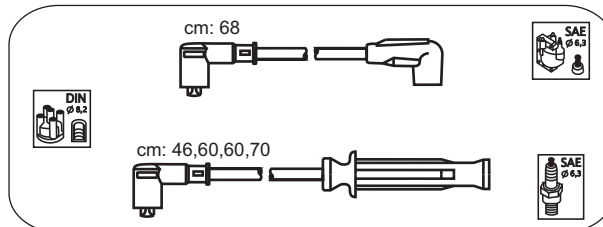

**RVS23**

**Rover**

Mini MK II  
Mini MK II Cabrio  
Mini Turbo

1.3 10.92 →  
1.3 09.94 →  
1.3 01.85 →

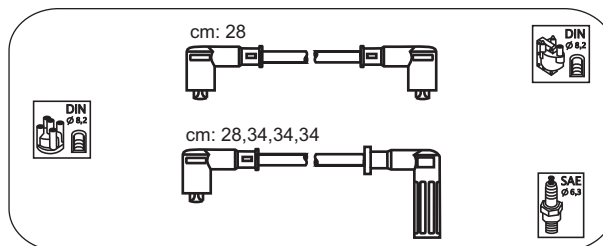

**RVS24**

**Rover**

25 16V  
45 16V  
75 16V

1.4i; 1.6i; 1.8i 00  
1.4i; 1.6i; 1.8i 00  
1.8i 00

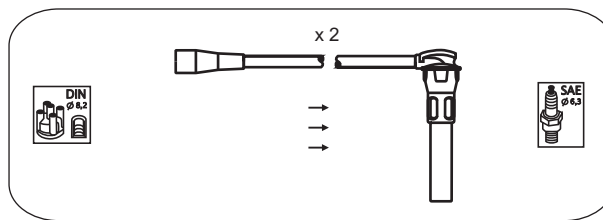

**NEW**  
**RVS25**

**Rover**

75 V6

2.0; 2.5 99 →

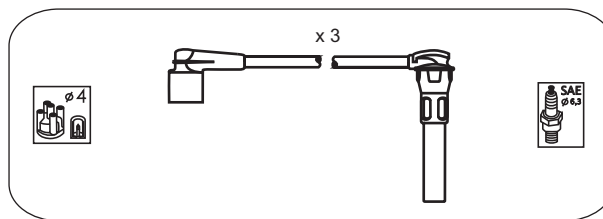

**NEW**  
**RVS26**

**Land Rover**

2000  
3500  
Defender 90 V8  
Defender 110  
Discovery V8 EFI  
Discovery V8 EFI  
Range Rover I  
Range Rover I V8 EFI  
Range Rover I V8 EFI  
Range Rover I V8 EFI  
Range Rover II V8 EFI

3.5 10.82-10.86  
3.5 10.82-10.86  
3.5 01.88 →  
3.5 01.86 →  
3.5 09.89-03.94  
4.0 06.94 →  
3.5 10.85-09-90  
3.5 10.85-09-90  
3.9 11.88 →  
4.3 09.92 →  
4.0 07.94 →

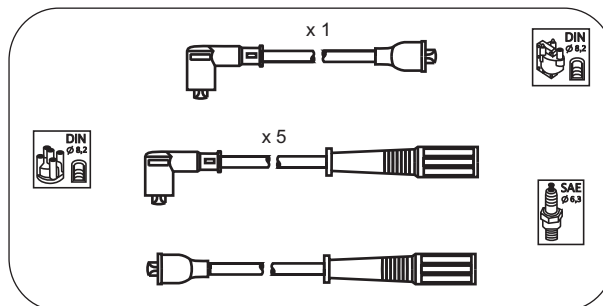

**NEW**  
**RVS27**

**Land Rover**

2000

2.0 10.82-10.86

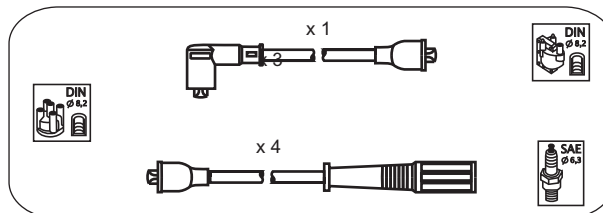

**NEW**  
**RVS28**

<b>RVS29</b>		<b>Land Rover</b> 2300 2600	---	---	<b>NEW</b>	01.77-10.86 01.77-10.86
<b>RVS30</b>		<b>Land Rover</b> Defender V8	3.9		<b>NEW</b>	11.98 →
<b>RVS31</b>		<b>Land Rover</b> Defender 90 Defender 110 Land Rover 90 Land Rover 110	2.3; 2.5 2.3; 2.5 2.5 2.5		<b>NEW</b>	01.88 → 01.86 → 09.85-07.90 09.85-07.90
<b>RVS32</b>		<b>Land Rover</b> Discovery I Discovery II 16V	2.0i 2.0i		<b>NEW</b>	01.90 → 06.94 →
<b>RVS33</b>		<b>Land Rover</b> Freelander	1.8		<b>NEW</b>	03.98 →
<b>RVS34</b>		<b>Land Rover</b> Land Rover 110	2.3		<b>NEW</b>	01.84-10.86
<b>RVS35</b>		<b>Land Rover</b> Range Rover II	4.0		<b>NEW</b>	06.98 →

**Land Rover**  
Range Rover II

4.6

07.94 →

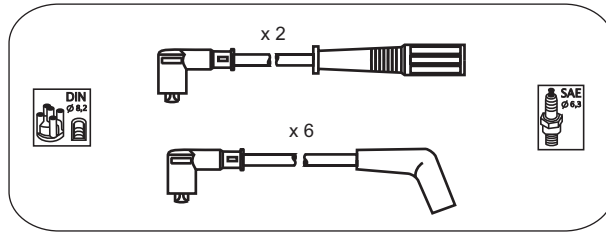

**NEW**  
**RVS36**