

**VL1**

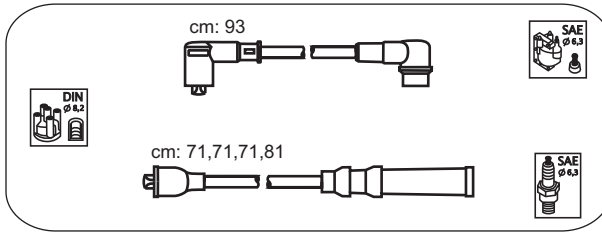

**Volvo**

240	2.0	01.85-06.88
340	2.0	01.85-12.87
360	2.0i	08.84-06.87

**VL2**

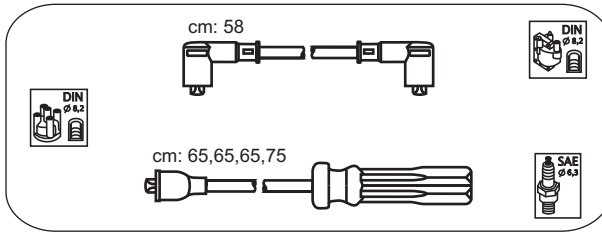

**Volvo**

240	2.0; 2.0i; 2.3i	08.88-12.90
240 Turbo	2.0; 2.1; 2.3	01.88 →
360 Turbo	2.0; 2.1; 2.3	01.87 →

**VL3**

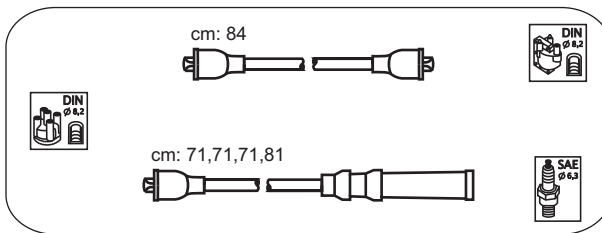

**Volvo**

240	2.0	01.81-12.84
240	2.0i	09.76-07.84
240	2.1	09.82-07.86
240 Turbo	2.1	09.81-07.84
240	2.2	07.76-07.85
240	2.3	09.81-07.84
240	2.3	01.84-12.87
240	2.3i	01.75-12.87
360	2.0	09.80-07.85

**VL4**

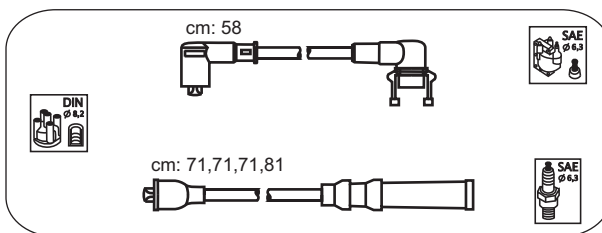

**Volvo**

240	2.3i	08.88-07.90
-----	------	-------------

**VL5**

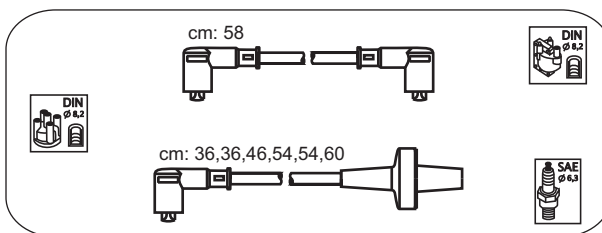

**Volvo**

240 V6	2.8i	08.80-08.84
260	---	05.75-07.80
260	2.8	02.77-08.84
740	2.8i	01.84-12.90
760	2.8	04.82-06.86
760	2.8i	01.85-12.87

**VL6**

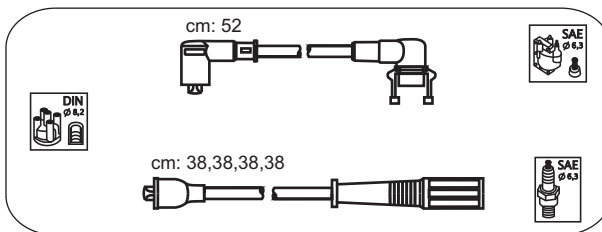

**Volvo**

340	1.4	01.84-12.89
360	1.4	01.84-12.89

**VL7**

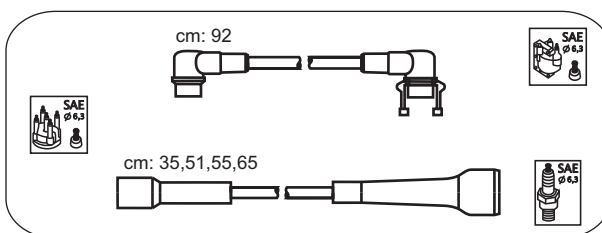

**Volvo**

340	1.7	01.84-12.89
360	1.7	01.84-12.89

**Volvo**

340 2.0 01.88 →  
360 2.0 01.88 →

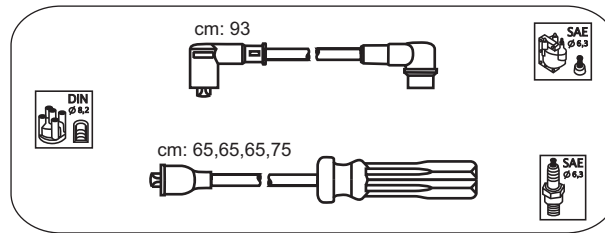

**VL8**

**Volvo**

440 1.7; 1.7i 01.88 →  
440 1.7i 01.89-12.93  
440 1.8 01.90 →  
440 Turbo 2.0i 01.93 →  
460 1.7; 1.7i 01.88 →  
460 1.8 03.90 →  
460 Turbo 2.0i 01.93 →  
480 1.7i 01.86 →  
480 2.0i 01.93 →

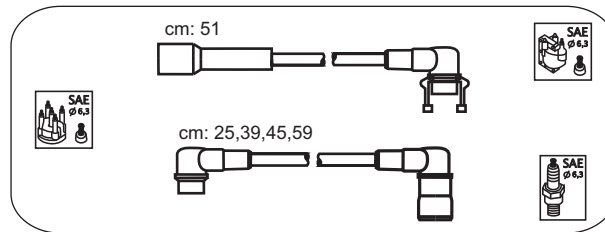

**VL9**

**Volvo**

440 1.6 01.88-12.91  
440 1.7i 09.88 →  
460 1.7i 01.88 →

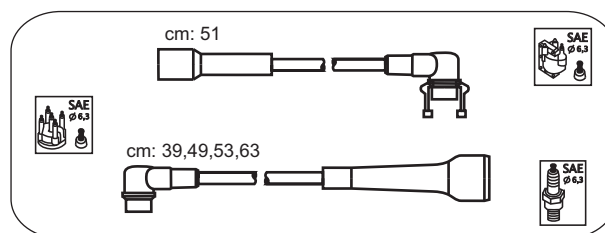

**VL10**

**Volvo**

440 Turbo 1.7i 09.88 →  
460 Turbo 1.7i 01.88-12.93  
480 Turbo 1.7i 01.88-12.93

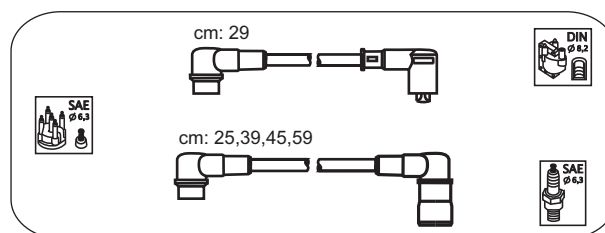

**VL11**

**Volvo**

740 2.0 01.87-07.91  
740 2.0i 01.84-12.90  
740 Turbo 2.0i 04.84-08.84  
740 Turbo 2.0i; 2.3i 01.87-12.90  
740 2.3i 04.84-12.90  
760 Turbo 2.3i 04.82-07.89  
780 2.0i 01.85 →  
940 2.3i 09.90 →  
960 2.0i; 2.3i 09.90 →  
960 Turbo 16V 2.3i 01.90 →

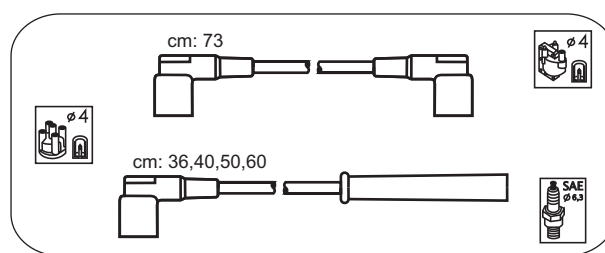

**VL12**

**Volvo**

740 Kombi (745) 2.0 08.85-07.95  
740 2.3 03.85 →  
740 Kombi (745) 2.3 08.85-07.86  
740 2.3i 08.84-08.87  
760 2.0i 08.84-12.90  
760 2.3i 01.87-12.90  
940, Turbo 2.0i; 2.3i 09.90 →  
940 (944) 2.3 08.92-07.95  
940 Kombi (945) 2.3 08.94 →  
940 Turbo 2.3 01.95 →  
960 2.0i; 2.3i 09.90 →

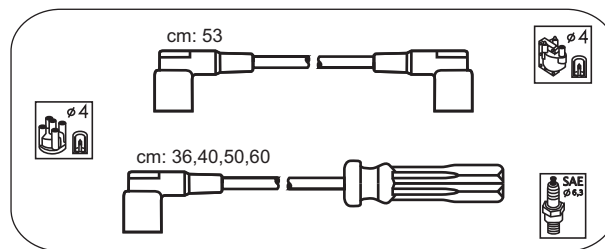

**VL13**

**Volvo**

740 2.0i 08.84-12.91

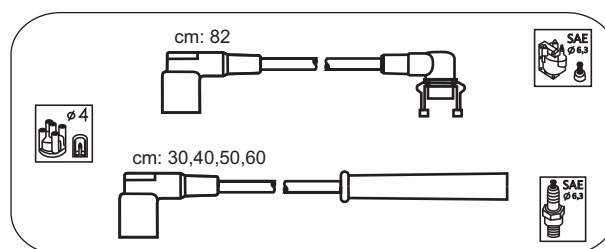

**VL14**

**VL15**

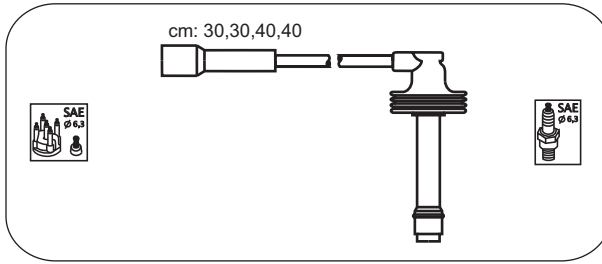

**Renault**

Laguna RTi-RXE  
Safrane RTE-RTX

2.0i 95 →  
2.0i 96 →

**Volvo**

760 Turbo (704)  
S40 (VS)  
S40 (VS) 16V  
S40  
S40 (VS) T  
V40 (VW) 16V  
V40 16V  
V40 16V  
V40 (VW) T4  
V40 (VW) T

2.3 08.82-07.84  
1.6 09.95 →  
1.6; 1.8 03.99 →  
1.8; 2.0 02.96 →  
2.0 10.97 →  
2.0 10.97 →  
1.6; 1.8 03.99 →  
1.6 12.95 →  
1.8; 2.0 08.96 →  
1.9 05.97 →  
2.0 10.97 →

**VL16**

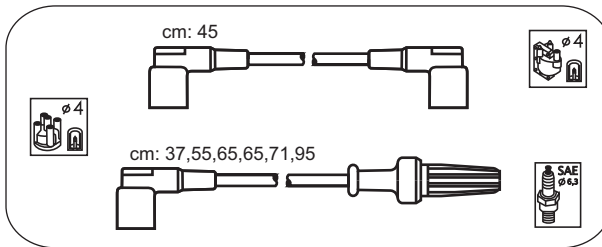

**Volvo**

760 V6  
780 V6  
940 V6  
960 V6

2.8i 08.86-07.91  
2.8i 05.86-07.90  
2.8i 09.90 →  
2.8i 09.90 →

**VL17**

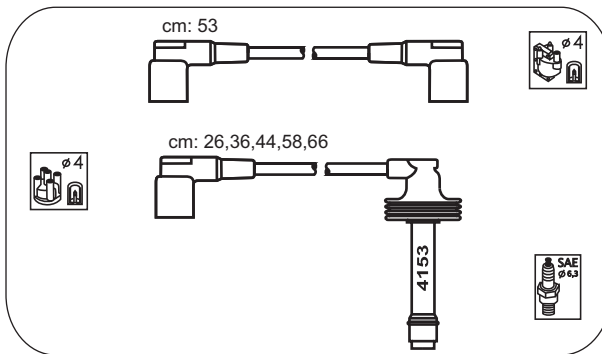

**Renault**

Safrane RXE-RXT

2.5 96 →

**Volvo**

850 20V  
850 20V T-5  
C70 20V  
C70 20V T-5  
S70 20V  
S70 20V T-5  
V70 20V  
V70 20V T-5

2.0; 2.5 93 →  
2.3 94 →  
2.0; 2.0T; 2.5T 03.98 →  
2.3 03.98 →  
2.0; 2.5; 2.5T 01.97 →  
2.3 01.97 →  
2.0; 2.5; 2.5T 01.97 →  
2.3 01.97 →

**NEW**

**VL18**

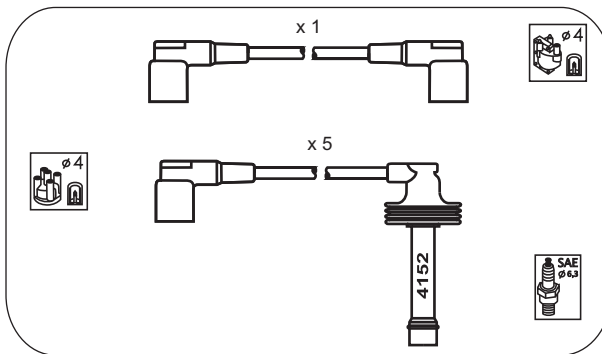

**Volvo**

850 10V  
S70 10V  
V70 10V

2.0; 2.5 93 →  
2.0; 2.5 01.97 →  
2.0; 2.5 01.97 →