

**Ford - wersja amerykańska**  
 Escort

1.9

90 →

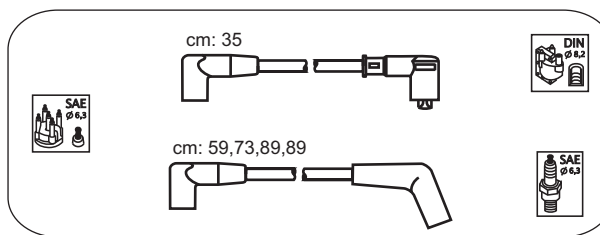

AM1

**Ford - wersja amerykańska**

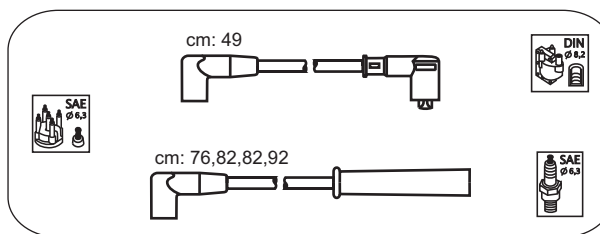
 Areostar  
 Taurus
2.3  
2.586-87  
87 →

AM2

**Chrysler**

 Jeep Cherokee  
 Chevrolet

2.8

85 →

Truck S.T. series V6

2.8

→ 94

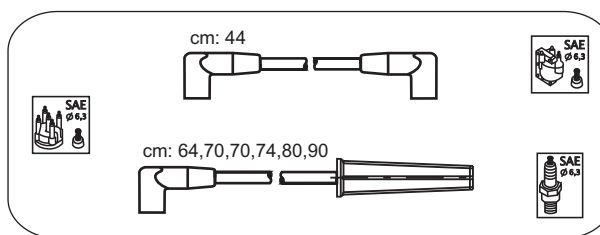

AM3

**Ford - wersja amerykańska**

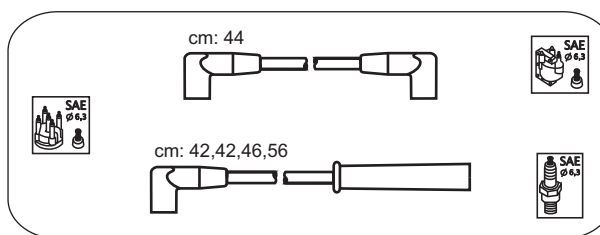
 Taurus  
 Tempo L4
2.5  
2.391 →  
87-94

AM4

**Ford - wersja amerykańska**

Escort

1.9

87-90

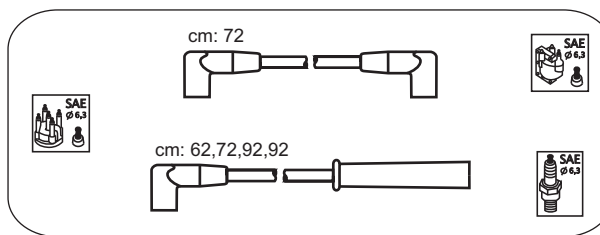

AM5

**Ford - wersja amerykańska**

 Areostar  
 Areostar  
 Probe V6  
 Sable V6  
 Taurus  
 Taurus  
 Tempo V6
2.8  
3.0  
3.0  
2.0  
3.0  
3.085 →  
86-90  
90-92  
87-93  
87 →  
91-94
**Mercury**

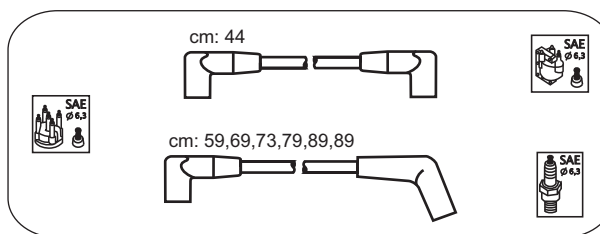
 Sabel V6  
 Topaz V6
3.0  
3.0→ 90  
92-94

AM6

**Ford - wersja amerykańska**

Areostar

3.0

90 →

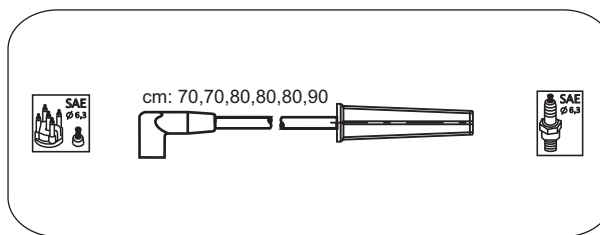

AM7

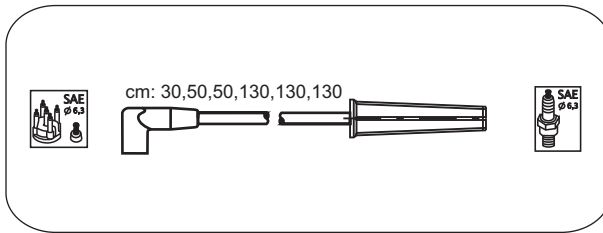
**AM8**

**Buick**

LeSabre V6	3.8	92-96
Park Avenue V6	3.8	92-95
Regal V6	3.1	95 →
Regal V6	3.8	89-95
Rivera V6	3.8	95 →
Rivera V6	3.8	91-93
Skylark V6	3.1	94-95

**Oldsmobile**

Silhouette V6	3.8	→ 95
Tornado V6	3.8	→ 92
98 Regency V6	3.8	→ 95

**Pontiac**

Bonneville V6	3.8	92-95
Grand Am V6	3.1	94-95
Grand Prix V6	3.1	95 →
Trans Sport	3.8	92 →

**Chevrolet**

Corsica, Beretta V6	3.1	94-95
Lumina	3.8	92 →
Monte Carlo V6	3.1	95 →

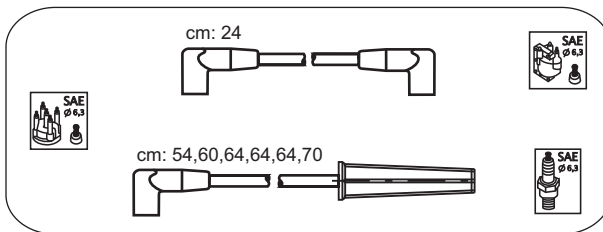
**AM9**

**Buick**

Regal V6	3.1	88-93
----------	-----	-------

**Oldsmobile**

Ciera V6	3.1	→ 90
Cutlass V6	3.1	→ 94

**Pontiac**

Grand Prix V6	3.1	→ 93
Trans Sport	3.1	91-95

**Chevrolet**

Celebrity V6	3.1	→ 90
Corsica V6	2.8	92 →
Lumina	3.1	92 →

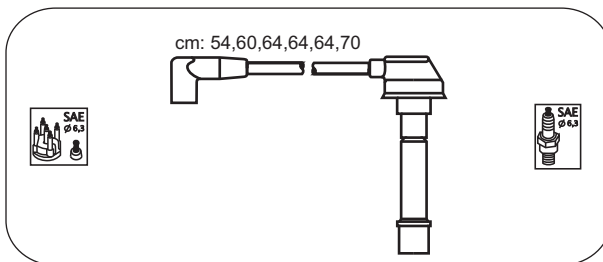
**AM10**

**Chrysler**

Concord	3.3; 3.5; 3.8	---
Fifth Ave. Imperial	3.3; 3.5; 3.8	---
Lebaron GTC	3.3; 3.8	---
LHS	3.3; 3.5; 3.8	---
New Yorker	3.3; 3.5; 3.8	---
Town & Country	3.3; 3.8	---

**Dodge**

Interpid	3.3; 3.5; 3.8	---
Dynasty	3.3; 3.8	---

**Eagle**

Vision	3.3; 3.5	---
--------	----------	-----

**Plymouth**

Voyager	3.3; 3.8	---
---------	----------	-----

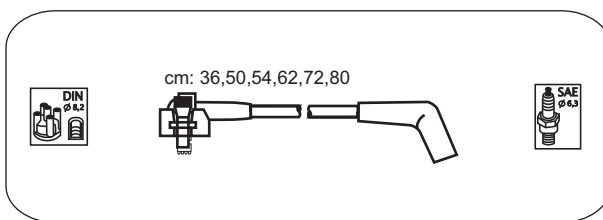
**AM11**

**Ford - wersja amerykańska**

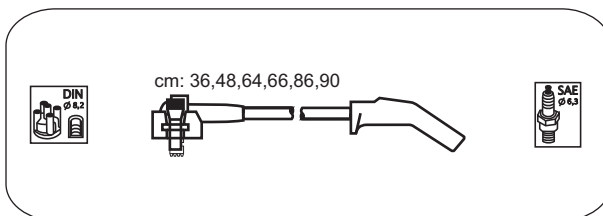
Taurus	3.0	96-99
--------	-----	-------

**AM12**

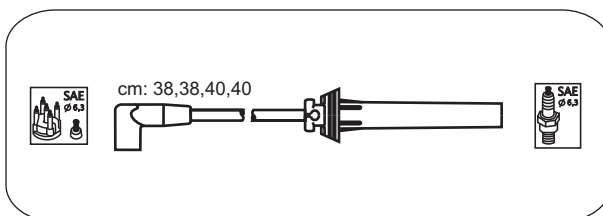
**Ford - wersja amerykańska**

Mustang	3.8	94-99
---------	-----	-------

**AM13**

**Dodge**

Neon	2.0	---
------	-----	-----

**Pontiac**  
 Firebird V6  
**Chevrolet**  
 Camaro V6

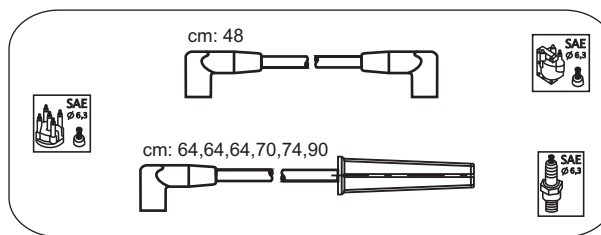
3.1	90-92
3.1	90-92



AM14

**Chrysler**
 Neon 16V  
 Sebring 16V  
 Voyager 16V

2.0	95-98
2.0	95-98
2.4	95-99

**Dodge**

Avanger 16V

2.0	95-98
-----	-------

**Eagle**

Taloon 16V

2.0	95-99
-----	-------

**Mitsubishi**

Eclipse 16V (USA)

2.0	97 →
-----	------

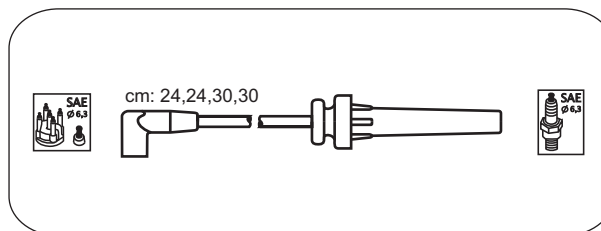

AM15

**Pontiac**  
 Grand Prix V6

2.8	---
-----	-----

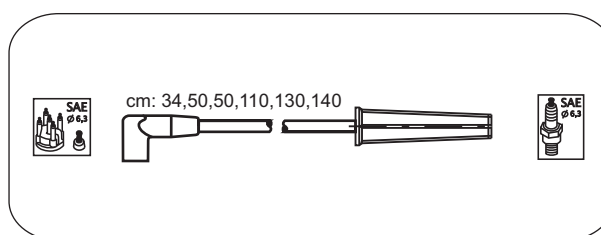

AM16

**Buick**

Century V6

3.1	94 →
-----	------

**Oldsmobile**

Ciera V6

3.1	92-95
-----	-------

Cutlass V6

3.1	→ 95
-----	------

**Pontiac**

Grand Prix V6

3.1	93 →
-----	------

Sunbird V6

3.1	→ 94
-----	------

**Chevrolet**

Cavalier V6

3.1	90-94
-----	-------

Corsica, Beretta V6

3.1	90-93
-----	-------

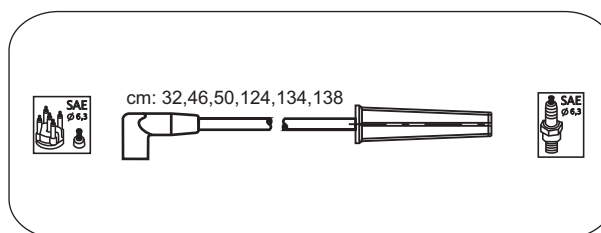

AM17

**Buick**

Century L4

2.2	93 →
-----	------

**Oldsmobile**

Ciera L4

2.2	93-95
-----	-------

**Pontiac**

Sunfire L4

2.2	95-96
-----	-------

**Chevrolet**

Cavalier L4

2.2	93-95
-----	-------

Corsica, Beretta L4

2.2	93-95
-----	-------

Truck S.T. series L4

2.2	94-96
-----	-------

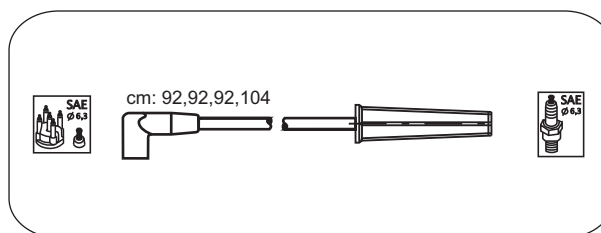

AM18

**Buick**

Century L4

2.5	91-93
-----	-------

**Oldsmobile**

Ciera L4

2.5	→ 92
-----	------

**Chevrolet**

Celebrity L4

2.5	→ 90
-----	------

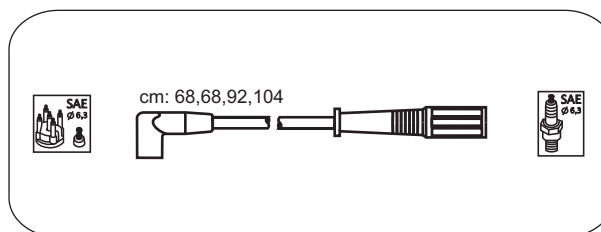

AM19

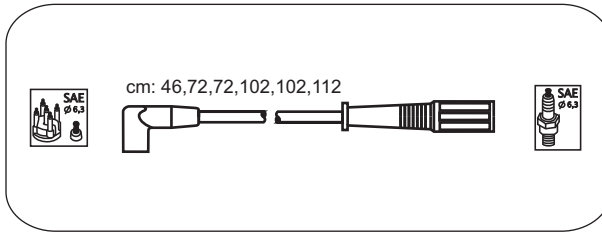
**AM20**

**Ford - wersja amerykańska**

Thunderbird V6 3.8 90-96

**Buick**

 Century V6 3.3 89 →  
 Electra, Park Avenue V6 3.8 90-92  
 Regal V6 3.8 92-93  
 Rivera V6 3.8 90-93  
 Skylark V6 3.3 90 →

**Oldsmobile**

 Achieva V6 3.3 92 →  
 Calais V6 3.3 → 91  
 Ciera V6 3.3 91-92  
 Delta 88 V6 3.8 → 90  
 Silhouette V6 3.1 → 95  
 88 Royale V6 3.8 → 94

**Pontiac**

 Bonneville V6 3.8 90-92  
 Firebird V6 3.4 93-95  
 Grand Am V6 3.3 → 93

**Chevrolet**

 Camaro V6 3.4 93-95  
 Monte Carlo V6 3.4 95 →

**Mercury**

Cougar V6 3.8 90-96

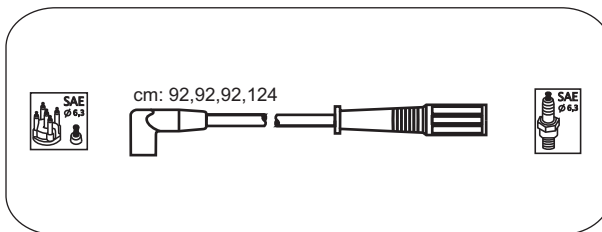
**AM21**

**Buick**

Skylark L4 3.1 90 →

**Oldsmobile**

Calais L4 2.5 → 91

**Pontiac**

Grand Am L4 2.5 → 91

**Chevrolet**

Cavalier L4 2.2 90-91

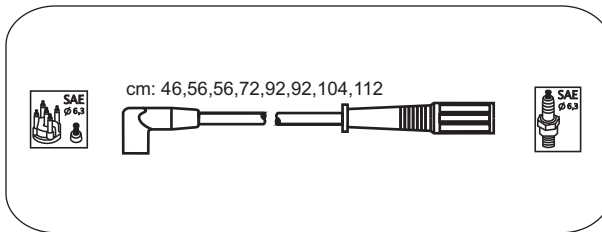
**AM22**

**Cadillac**

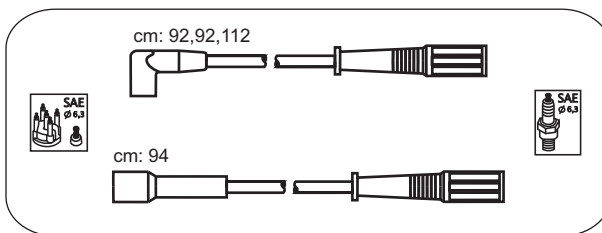
 Allante V8 4.5 89-92  
 DeVille V8 4.5 90 →  
 DeVille V8 4.9 91-95  
 Eldorado, Seville V8 4.5 90 →  
 Eldorado, Seville V8 4.9 91-93

**AM23**

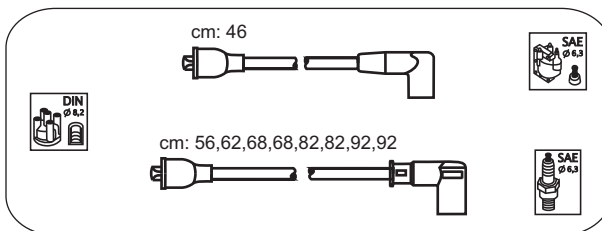
**Chevrolet**

 Cavalier L4 2.2 92 →  
 Corsica, Beretta L4 2.2 92 →

**AM24**

**Pontiac**

Firebird V8 5.7 94-96

**Chevrolet**

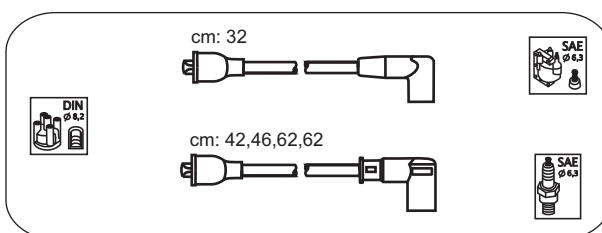
 Camaro V8 5.7 94-95  
 Corvette V8 5.7 92-95

**AM25**

**Buick**

Roadmaster V8 5.7 94-95

**Chevrolet**

 Caprice V8 4.3; 5.7 94-95  
 Impala V8 4.3; 5.7 94-95

**Pontiac**  
Firebird V6  
**Chevrolet**  
Camaro V6  
Caprice V6

3.8

95 →



cm: 54,70,80,80,90,102

**AM26**

**Chevrolet**  
Corvette V8

5.7

90-91



cm: 66,66,66,70,80,100,110,110

**AM27**

**Chevrolet**  
Caprice V6

4.3

→ 90



cm: 18



cm: 60,60,66,90



cm: 82,92

**AM28**

**Oldsmobile**  
Custom Cruiser V8  
**Cadillac**  
Brougham V8  
**Chevrolet**  
Caprice V8

5.0

→ 90

5.0

90 →

5.0

→ 90



cm: 56,56,62,62,68,92,104,104

**AM29**

**Oldsmobile**  
Bravada V6  
**Chevrolet**  
Truck C.K series V6  
Truck G series V6  
Truck S.T series V6

4.3

→ 91

4.3

→ 95

4.3

→ 90

4.3

→ 91



cm: 30



cm: 66,70,70,80



cm: 68,92

**AM30**

**Chevrolet**  
Truck C.K series V8  
Truck G series V8

5.0; 5.7

→ 95

5.0; 5.7

→ 96



cm: 26



cm: 66,66,66,80,80,90



cm: 104,104

**AM31**

**AM32**

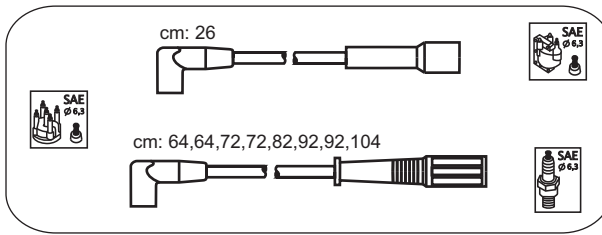

**Chevrolet**

Truck C.K series V8	7.4	94-95
Truck G series V8	7.4	94-96

**AM33**

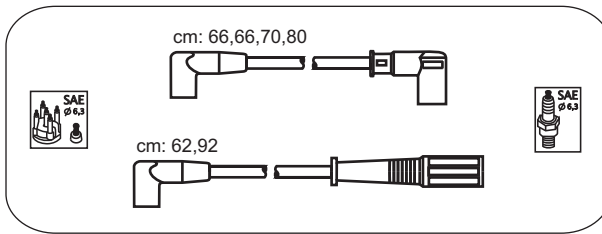

**Oldsmobile**

Bravada V6	4.3	92-94
<b>Chevrolet</b>		
Truck G series V6	4.3	92-96
Truck S.T series V6	4.3	92-95

**AM34**

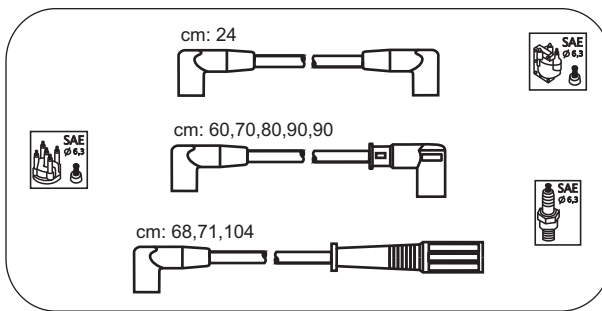

**Buick**

Roadmaster V8	5.0	91 →
Roadmaster V8	5.7	92-93
<b>Oldsmobile</b>		
Custom Cruiser V8	5.0; 5.7	91 →
<b>Pontiac</b>		
Firebird V8	5.0; 5.7	→ 92
<b>Cadillac</b>		
Brougham V8	5.7	90-92
<b>Chevrolet</b>		
Camaro V8	5.0; 5.7	89-92
Caprice V8	5.0	89-94
Caprice V8	5.7	→ 93
Truck C.K series V8	7.4	90-93
TRUCK G series V8	7.4	90-93

**AM35**

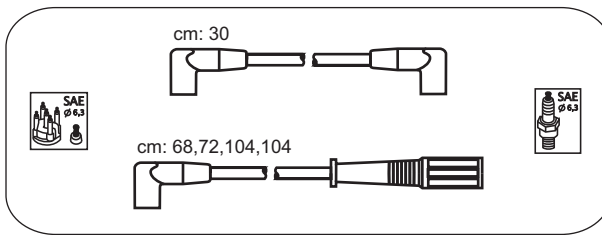

**Chevrolet**

Truck S.T series L4	2.5	→ 94
---------------------	-----	------

**AM37**

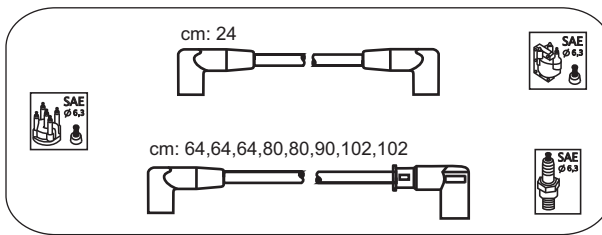

**Chevrolet**

Truck S.T series V8	4.3	95 →
---------------------	-----	------

**AM38**

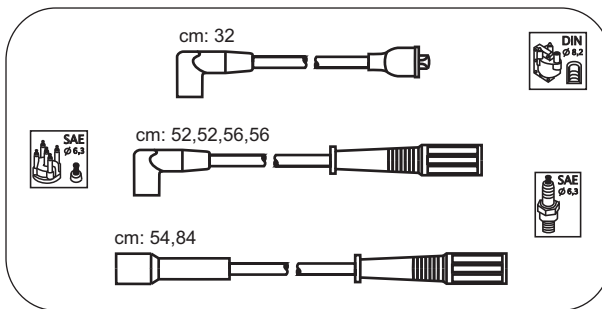

**Ford - wersja amerykańska**

Bronco II V6	2.9	→ 90
Ranger V6	2.9	→ 92

**Ford - wersja amerykańska**

Country Squire V8	5.0	88-90
Crown Victoria V8	5.0	89-91
Thunderbird V8	5.0	88-92

**Mercury**

Colony Park V8	5.0	→ 91
Grand Marquis V8	5.0	→ 91

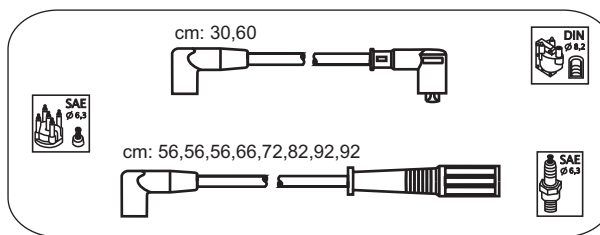
**AM39****Ford - wersja amerykańska**

Mustang L4	2.3	88-93
------------	-----	-------

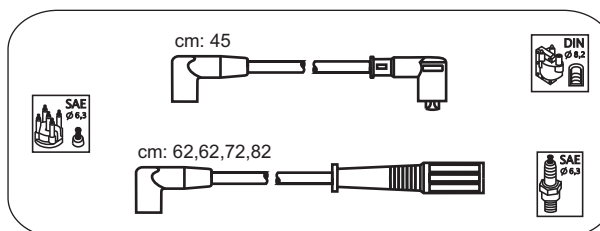
**AM40****Nissan**

Quest	3.0	---
-------	-----	-----

**Mercury**

Villager GS V6	3.0	-94-
----------------	-----	------

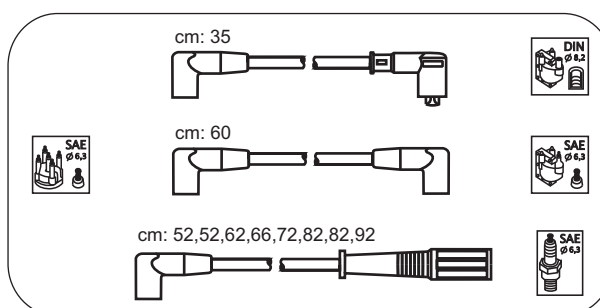
**AM41**

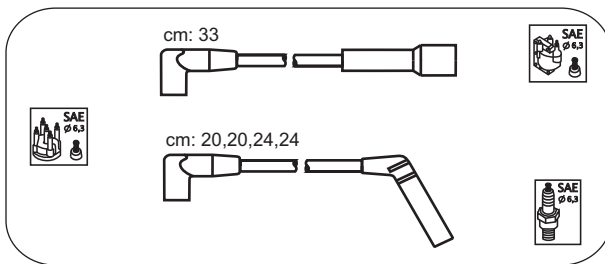
**LR1**

**Chrysler**

Jeep Cherokee (J)

2.5

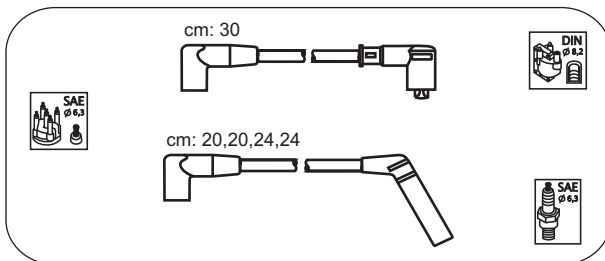
11.96 →

**LR2**

**Chrysler**

Jeep Cherokee (J) gaźnik

2.5

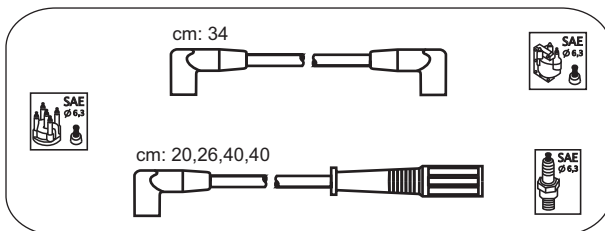
11.96 →

**LR3**

**Chrysler**

Jeep Cherokee (XJ)

2.5

12.91 →

Jeep Wrangler

2.5

08.96 →

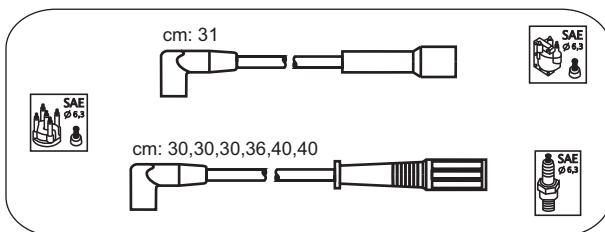
**LR4**

**Chrysler**

Jeep Cherokee (XJ)

4.0

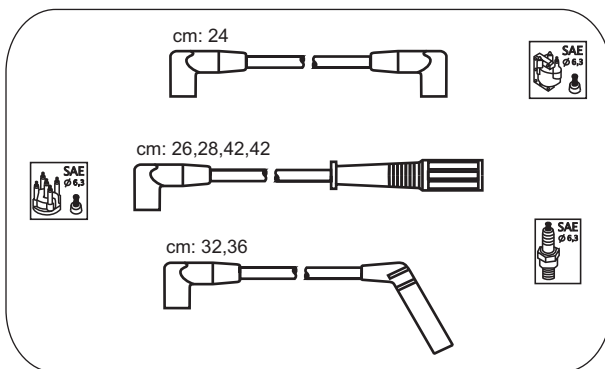
01.88 →

**LR5**

**Chrysler**

Jeep Cherokee (XJ)

4.0

12.91 →

Jeep Grand Cherokee (MX,Z)

4.0

09.91 →

Jeep Wrangler

4.0

08.96 →

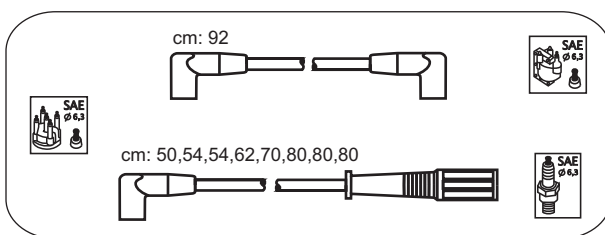
**LR6**

**Chrysler**

Jeep Grand Cherokee (Z)

5.2

10.95 →

Jeep Grand Cherokee (ZJ)

5.2

10.92 →



**Chrysler**  
Voyager

3.0i

01.95 →

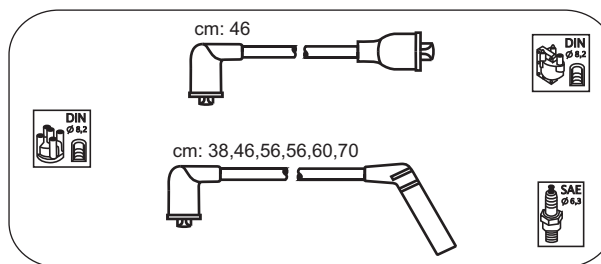

LR7

**Chrysler**  
Voyager

3.3i; 3.8

96-99

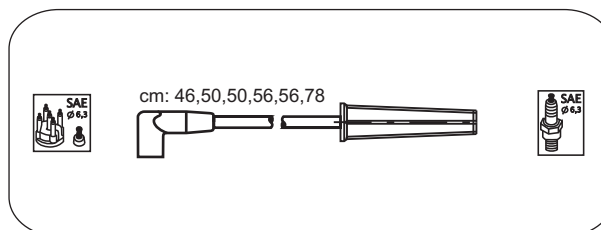

LR8

**Chrysler**  
Voyager

3.3i; 3.8

→ 96

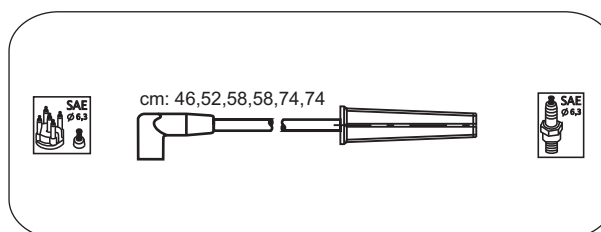

LR9

**Chrysler**  
Voyager  
Voyager

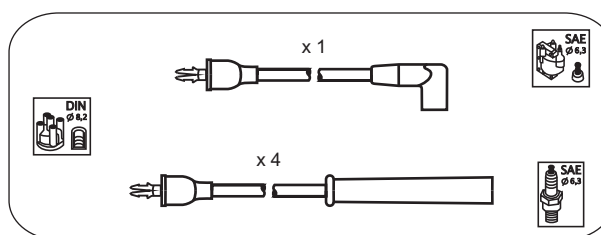
2.0i  
2.4i01.95 →  
01.95-12.95

**NEW**  
LR10

**Chrysler**  
Voyager

2.4i

01.96 →

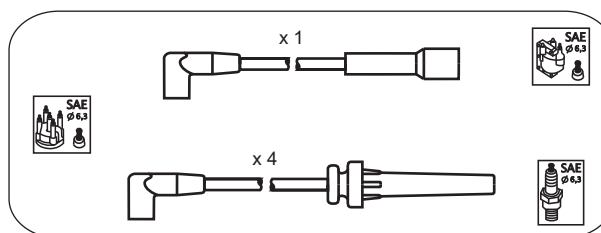

**NEW**  
LR11

**Chrysler**  
Voyager

2.5i

01.88 →

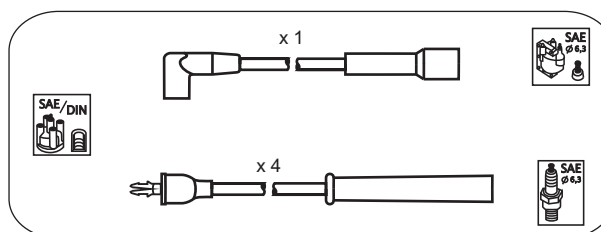

**NEW**  
LR12

**Chrysler**  
PT Cruiser 16V

2.0; 2.4

06.00 →

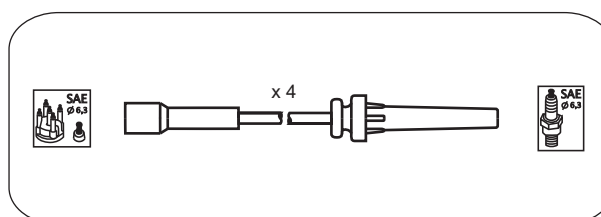

**NEW**  
LR13